

Technical specifications	Viper S2 Single	Viper S2 Dual
Voltage:	12V	12V
Average consumption:	1Amp blue and red 0,75 Amp amber 1,5 Amp clear and green	2,2 Amp blue, amber, red, clear and green
Operating temperature:	-20°C to +50°C	-20°C to +50°C
Dimensions:	111 x 46 x 142 mm	220 x 46 x 142 mm
Weight:	300gr	440gr

## HOW TO ORDER

Choose reference from below:

### VIPER S2 SINGLE Solaris

<b>R65</b> 2010549	<b>VIPER S2 SINGLE Solaris</b> , blue LED and spreader clear lens, 5 flash patterns, cigarette plug, windshield mount, 12 V, R65 approval.
2010548	<b>VIPER S2 SINGLE Solaris</b> , amber LED and spreader clear lens, 5 flash patterns, cigarette plug, windshield mount, 12 V.
2010550	<b>VIPER S2 SINGLE Solaris</b> , red LED and spreader clear lens, 5 flash patterns, cigarette plug, windshield mount, 12 V.
329000-5	<b>VIPER S2 SINGLE Solaris</b> , white LED and smooth clear lens, 23 flash patterns, cigarette plug, windshield mount, 12 V.
329000-6	<b>VIPER S2 SINGLE Solaris</b> , green LED and smooth clear lens, 23 flash patterns, cigarette plug, windshield mount, 12 V.

### VIPER S2 DUAL Solaris

2010592	<b>VIPER S2 DUAL Solaris</b> , blue/blue LED and smooth clear lens, 25 flash patterns, cigarette plug, windshield mount, 12 V.
2010593	<b>VIPER S2 DUAL Solaris</b> , blue/red LED and smooth clear lens, 25 flash patterns, cigarette plug, windshield mount, 12 V.
329000-42	<b>VIPER S2 DUAL Solaris</b> , red/amber LED and smooth clear lens, 25 flash patterns, cigarette plug, windshield mount, 12 V.
329000-43	<b>VIPER S2 DUAL Solaris</b> , red/blue LED and smooth clear lens, 25 flash patterns, cigarette plug, windshield mount, 12 V.
329000-44	<b>VIPER S2 DUAL Solaris</b> , red/red LED and smooth clear lens, 25 flash patterns, cigarette plug, windshield mount, 12 V.
2010591	<b>VIPER S2 DUAL Solaris</b> , amber/amber LED and smooth clear lens, 25 flash patterns, cigarette plug, windshield mount, 12 V.
329000-23	<b>VIPER S2 DUAL Solaris</b> , amber/blue LED and smooth clear lens, 25 flash patterns, cigarette plug, windshield mount, 12 V.
329000-24	<b>VIPER S2 DUAL Solaris</b> , amber/red LED and smooth clear lens, 25 flash patterns, cigarette plug, windshield mount, 12 V.
329000-55	<b>VIPER S2 DUAL Solaris</b> , white/white LED and smooth clear lens, 25 flash patterns, cigarette plug, windshield mount, 12 V.

### VIPER S2 DUAL Solaris Synchronizable

329001-32	<b>VIPER S2 DUAL Solaris</b> , blue/amber LED and smooth clear lens, 25 flash patterns, synchronizable with other lights, windshield mount, 12 V.
329001-34	<b>VIPER S2 DUAL Solaris</b> , blue/red LED and smooth clear lens, 25 flash patterns, synchronizable with other lights, windshield mount, 12 V.

**FEDERAL SIGNAL VAMA**  
Public Safety Systems



# VIPER S2 SOLARIS Series

## Internal warning Light

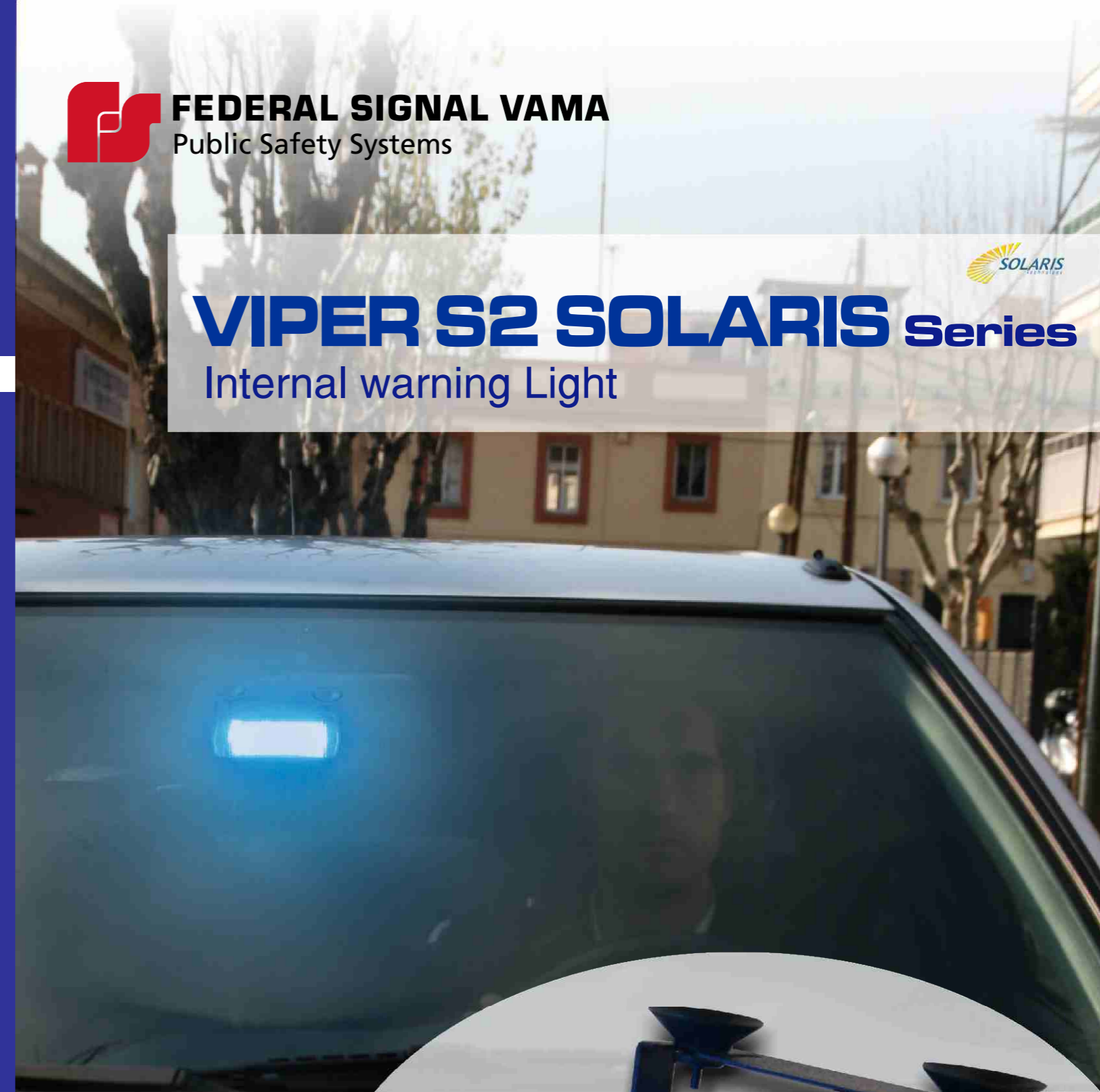

**FEDERAL SIGNAL VAMA**  
Public Safety Systems

ISO 9001:2000 Certified Company  
Dr. Ferrán, 7  
08339 VILASSAR DE DALT  
BARCELONA - SPAIN  
Phone 34 93 741 79 32  
Fax 34 93 750 78 23  
Email: marketing@vama.es

[www.fedsigvama.com](http://www.fedsigvama.com)

# VIPER S2 SOLARIS Series

The new **VIPER S2 LED** lights provide, with the **Solaris** exclusive **technology** from **Federal Signal Vama**, the ideal solution for camouflaged vehicles or reinforce the lighting on emergency vehicles. Viper S2 Solaris is windshield mount. Main advantages are:

 **HIGH INTENSITY.** Thanks to LED Solaris technology, its spread lens and special light inclination. Molded scalloped facets at the rear of the reflector direct LED light forward to form an impressive block of illumination. Two inboard side reflectors mirror high intensity LED light to the side producing wide-angle off-axis warning. Combined, the Viper S2 delivers the most effective compact, lightweight warning light available.

 **USER FRIENDLY.** Plug & Play connection, through cigarette plug with a 2,7 m cable. Flash patterns could be changed just pushing a button.

 **EASY, VERSATILE INSTALLATION.** Specially designed to be quickly mounted, with a minimum manipulation. Thanks to its compact dimensions, it could be installed on every part of the vehicle.

 **LOW AMP DRAW AND LONG LIFE.** Optimizes vehicle battery performance.



Viper S2 Solaris Dual blue-red

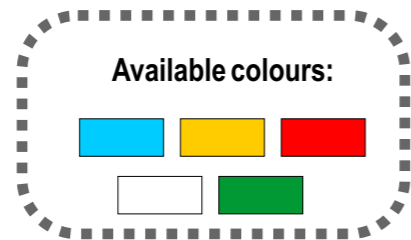

**Approvals**  
Blue light satisfy R65 European Directive. All models satisfy Electromagnetic Compatibility law 2004/104.



Surface mounting application on the rear part of the vehicle.



Viper S2 Solaris could reinforce priority lights.

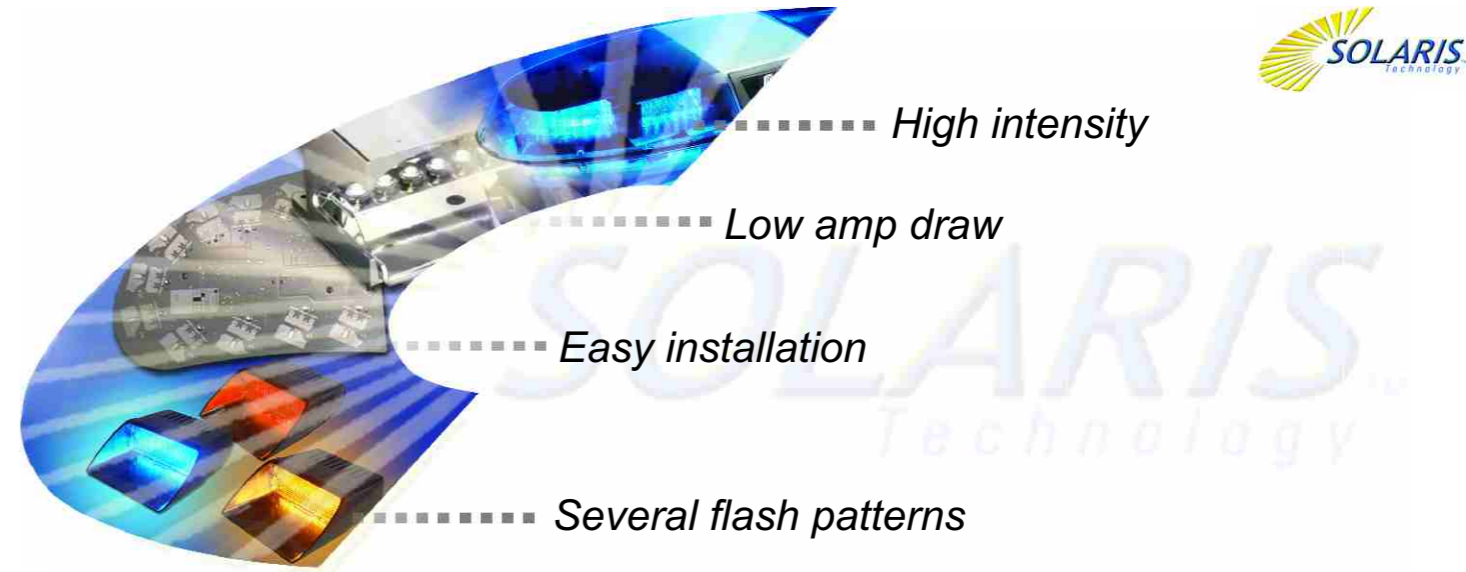

Federal Signal Vama offers to his customers, the high performance and efficiency **Solaris** technology. Traditional light systems spread it in a random direction, LED **Solaris** Technology reflects a strong light beam where it is needed most, on a wide angle, avoiding dark spots.

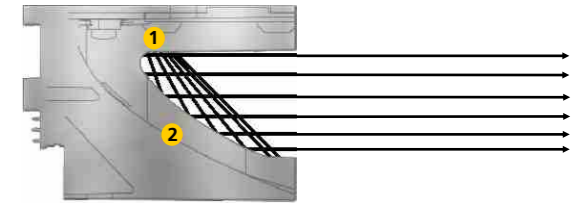

- 1 Last generation LED diodes.
- 2 Parabolic reflector maximizes LED light intensity.

**Viper S2 Solaris** is an excellent internal warning light, due its special and compact design. Their lights could operate independently or in a synchronized way, with 5, 23 or 25 flash patterns built-in.

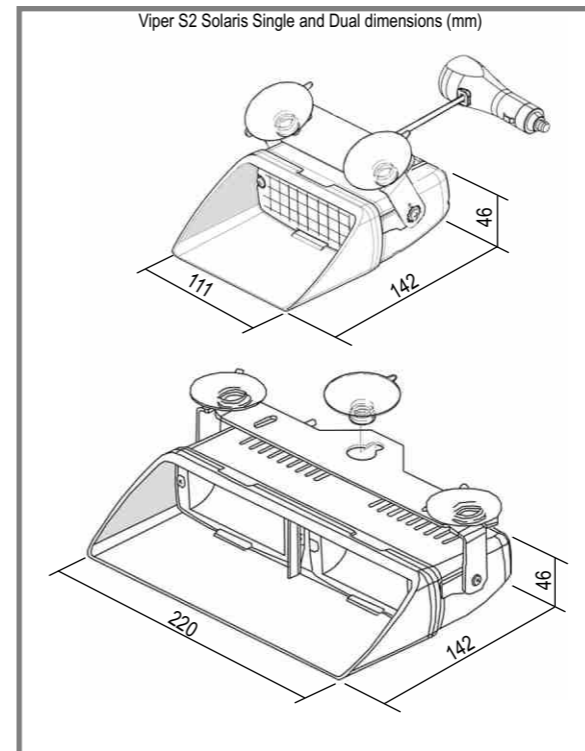

Flash patterns selection button.



Rounded an easy removed frame in order to direct the beam light and protect inside vehicle from flashes.

Immediate installation thanks to a cigarette plug with an ON/OFF button (except sincronized Viper S2 Dual Solaris).